

## Smart Active Balance (EK-24S10EB) Operation Instruction



Scan the QR code to download the app.



Scan the QR code to access the official website

## Product warranty terms

**Product model:** Smart Active Balance

**Warranty period :** One year

Firstly, thank you for purchasing the Smart Active Balance from Shenzhen Jiatong Electronics Co., Ltd

Our company provides quality warranty for hardware products and accessories sold by our company, with the warranty period as shown above. If there is a malfunction due to quality reasons during the warranty period, the company has the right to choose to repair or replace the entire product after receiving notification of the product malfunction and conducting inspection and verification. The complete replacement product can be new or nearly new.

1. Shenzhen Jiatong Electronics Co., Ltd. guarantees that the products have been fully tested.
2. Shenzhen Jiatong Electronics Co., Ltd does not guarantee uninterrupted use of the product during the repair process. But the company should ensure that the faulty product is repaired within a reasonable period of time.
3. The product warranty period starts from the date of shipment or the date of installation by Shenzhen Jiatong Electronics Co., Ltd. If the installation of the company's products is not started within 30 days after the date of shipment due to user schedule or delay, the product warranty period shall be calculated from the 31st day after the date of shipment.
4. Shenzhen Jiatong Electronics Co., Ltd does not provide free warranty for product failures and damages caused by any of the following situations:
  - (1) Improper use or improper maintenance;
  - (2) Software, accessories, components, or other items not provided by Shenzhen Jiatong Electronics Co., Ltd
  - (3) Unauthorized disassembly, modification and misuse;
  - (4) Use beyond the scope specified in the product technical specifications;
  - (5) Improper transportation, handling and storage;
  - (6) Failure or damage caused by other non-quality reasons (such as earthquake, war, traffic accident, etc.).

Within the scope permitted by law, the above warranty terms are the only and explicit, and there are no other warranty terms, whether written or oral. Explicitly refuse to acknowledge any implied warranty and commercial terms.

---

### Copyright Notice

All products sold by Shenzhen Jiatong Electronics Co., Ltd or software and documents sold with hardware products are copyrighted by Shenzhen Jiatong Electronics Co., Ltd. Shenzhen Jiatong Electronics Co., Ltd reserves all Copyrights in products and documents. The purchase of the Product by the User does not constitute any license by the User with respect to copyright. Any reproduction and sale without the written permission of Shenzhen Jiatong Electronics Co., Ltd is prohibited.

---

---

# TABLE OF CONTENTS

- 1. Description ..... 1**
- 2. Specifications ..... 1**
- 3. Product photos ..... 2**
  - 3.1. Product Appearance .....2
  - 3.2. Packaging Picture ..... 3
  - 3.3. Product Accessories .....3
- 4. Connector terminal ..... 4**
  - 4.1. Connector picture ..... 4
  - 4.2. Connector pin description .....4
- 5. Indicator description ..... 5**
- 6. Product Size ..... 5**
- 7. Introduction to Balance ..... 6**
  - 7.1. Balance principle ..... 6
  - 7.2. Single moving capacity .....6
  - 7.3. Small-capacity balancing policy .....6
- 8. Installation method and precautions ..... 6**
  - 8.1. Unpacking check and precautions ..... 6
  - 8.2. Instructions for installing the equalizer ..... 7
    - 8.2.1. 24S Wiring Diagram .....7
    - 8.2.2. 10S Wiring Diagram .....7
    - 8.2.3. 5S Wiring Diagram ..... 8
    - 8.2.4. 32S Cascade Diagram ..... 8
- 9. APP Installation and Use ..... 9**
  - 9.1. APP Installation ..... 9
  - 9.2. APP Use ..... 9
    - 9.2.1. Pre-use inspection ..... 9
    - 9.2.2. APP Connect device procedure ..... 9
  - 9.3. Notice ..... 12
- 10. Phenomenon description ..... 13**
  - 10.1. General fault analysis and elimination ..... 13
  - 10.2. Buzzer alarm description ..... 14
  - 10.3. Buzzer description ..... 14
- 11. Safety protection measures and transportation and storage ..... 15**
  - 11.1. Safety precautions ..... 15
  - 11.2. Transportation ..... 15
  - 11.3. Storage ..... 15

## 1. Description

The Smart Active Balance is a balancing management system tailored for large capacity series connected battery packs.

This balancer uses supercapacitors as a medium to achieve active energy transfer balancing.

The APP sets the balancing current to the actual working balancing current value, which is independent of the voltage difference between the series connected battery cells in the battery pack.

The voltage collection range is 1.5V ~ 4.5V, with an accuracy of 1mV. Suitable for mainstream ternary lithium, lithium iron phosphate, and lithium titanate batteries on the market. Supports 2 to 24 battery strings, supports cascading use, and supports disorderly power on.

This balancer has Bluetooth communication function and is equipped with a mobile app software. Single battery voltage, maximum voltage, minimum voltage, average voltage, maximum voltage difference, total voltage of the battery pack, real-time balancing current, operating time, balancing status, and device temperature can be viewed through Bluetooth connection to the balancer. The device balancing parameters can be modified online.

It is commonly used in battery packs for small sightseeing vehicles, commuters, shared cars, high-power energy storage, backup power sources for base stations, solar power stations, and other products. It can also be used for battery balancing maintenance, repair, and other occasions.

## 2. Specifications

<b>Product model</b>	EK-24S10EB
<b>Unit quantity (S)</b>	External power supply: 2S ~ 24S
	The battery supply: 4S ~ 24S
<b>Cascading</b>	√
<b>Product size</b>	L156 x W144 x T28 (mm)
<b>Weight (package concluded)</b>	810g
<b>Supported battery type</b>	NCM / LFP / LTO
<b>Single cell voltage collection range</b>	1.5V ~ 4.5V
<b>Undervoltage protects sleep voltage</b>	APP can be customized Settings: 1.5 ~ 4.2V
<b>Equilibrium method</b>	Time-sharing single channel transfer, point-to-point energy transfer.
<b>Equilibrium current</b>	APP can be customized Settings: 1A ~ 10A (EK-24S10EB)
<b>Voltage equalization accuracy</b>	APP can be customized Settings: 1mV (TYP)
<b>Whether an external power supply is required</b>	External power supply (accuracy ±1mV)
	Battery powered (accuracy ±3mV)
<b>Power failure detection function</b>	√
<b>Wrong wire protection function</b>	√
<b>Reverse protection</b>	√
<b>Fault alarm function</b>	√
<b>Buzzer</b>	APP can be customized Settings
<b>Power dissipation</b>	At equilibrium ≈ 1W, Stop equilibrium ≈ 0.5W
<b>Operating ambient temperature</b>	-20°C ~ +55°C

### 3.Product photos

#### 3.1.Product Appearance



### 3.2.Packaging Picture



### 3.3.Product Accessories



Parts name	Part specification			PCS	Notes
	Wire gauge	Wire length	Peeled tin plated		
7 Pin	18AWG	80cm	3mm	1	
9 Pin	18AWG	80cm	3mm	2	
DC adapter	18V or 24V (Random) VDE or UL CSA			1	

## 4. Connector terminal

### 4.1.Connector picture



**Connector P1**

**Connector P2**

**Connector P3**

### 4.2.Connector pin description

Connector	Pin	Pin name	Description
<b>P1</b>	1	B-	The negative end of the first battery
	2	B1	The positive electrode of the first battery
	3	B2	The positive electrode of the second battery
	4	B3	The positive electrode of the thirdly battery
	5	B4	The positive electrode of the fourthly battery
	6	B5	The positive electrode of the fifth battery
	7	B6	The positive electrode of the sixth battery
	8	B7	The positive electrode of the seventh battery
	9	B8	The positive electrode of the eighth battery
<b>P2</b>	1	B9	The positive electrode of the ninth battery
	2	B10	The positive electrode of the tenth battery
	3	B11	The positive electrode of the 11th battery
	4	B12	The positive electrode of the 12th battery
	5	B13	The positive electrode of the 13th battery
	6	B14	The positive electrode of the 14th battery
	7	B15	The positive electrode of the 15th battery
	8	B16	The positive electrode of the 16th battery
	9	B17	The positive electrode of the 17th battery
<b>P3</b>	1	B18	The positive electrode of the 18th battery
	2	B19	The positive electrode of the 19th battery
	3	B20	The positive electrode of the twentieth battery
	4	B21	The positive electrode of the 21st battery
	5	B22	The positive electrode of the 22st battery
	6	B23	The positive electrode of the 23st battery
	7	B24	The positive electrode of the 24st battery

**4.3.DC Power Supply**



**4.4.External TTL communication & Password Reset**

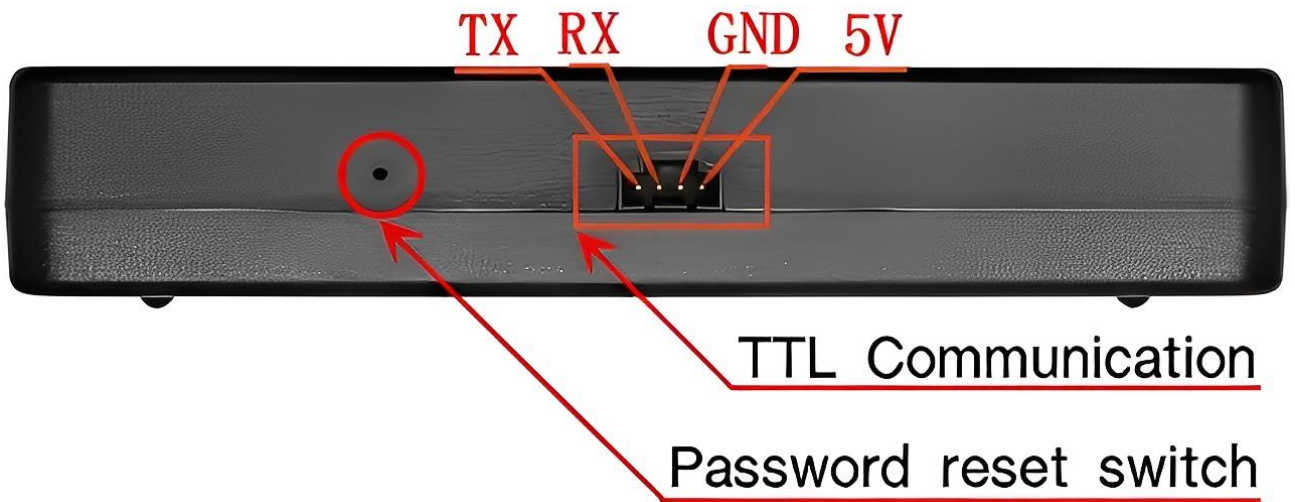

**5.Indicator description**



Indicator	Indicator color	Indicator Steady on	Indicator Flashed
Fault	Red	The number of batteries does not match the configuration	The resistance of the equalizing line is too large
Balance	Yellow	Balanced completion	In balance
Bluetooth	Blue	Connection successful	Connection break
Power supply	Green	Power good	/

## 6.Product Size

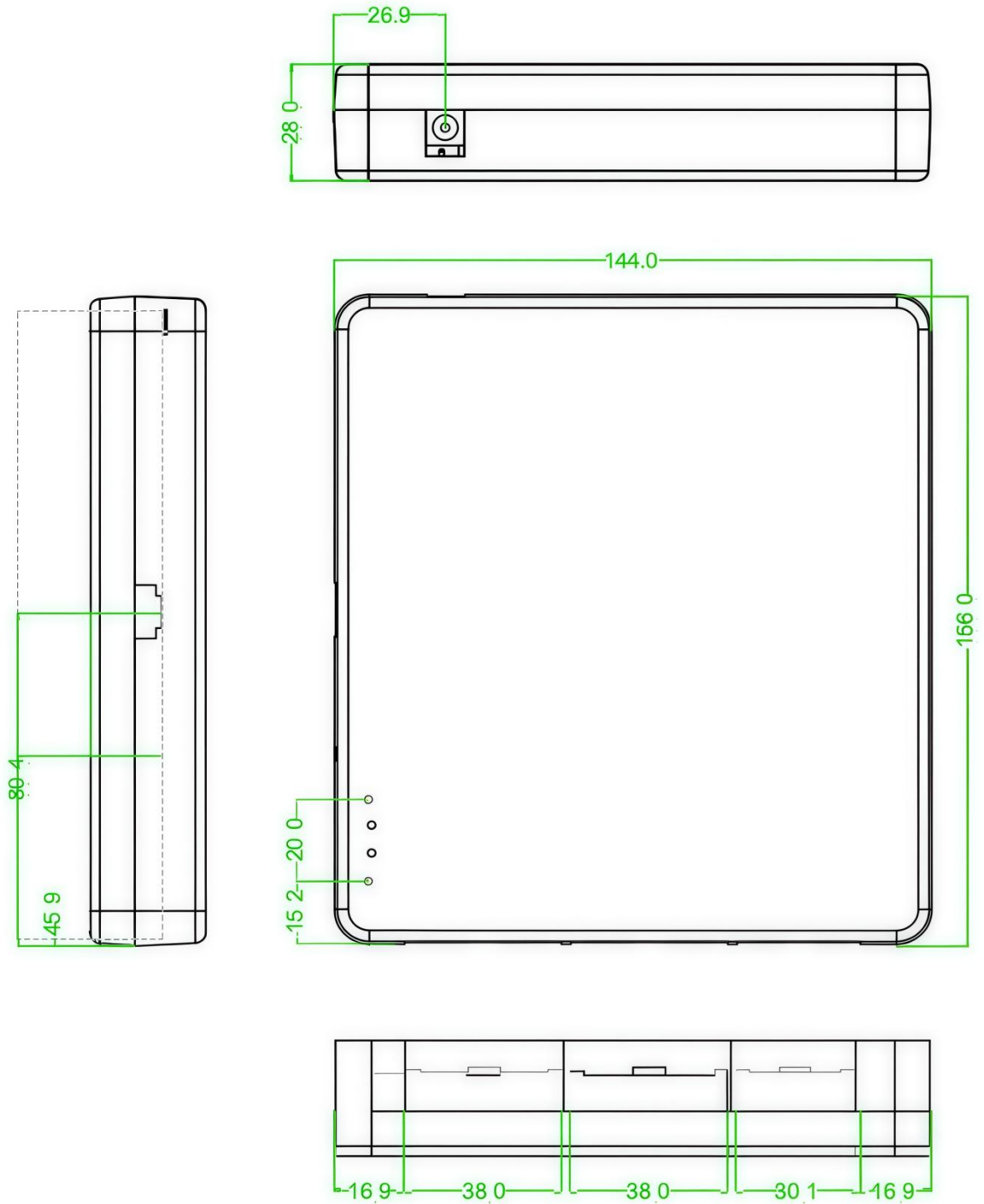

Notes : Unit is mm,the error is  $\pm 0.5\text{mm}$

## 7. Introduction to Balance

### 7.1. Balance principle

The equalization process of the active equalizer consists of the following three steps, which are cycled in turn until the maximum pressure difference is within the set range:

1. The largest monomer and the smallest monomer were detected;
2. The maximum unit charges the ultracapacitor in the equalizer. The charging current is the set current, and the maximum is 10A;
3. The ultracapacitor in the equalizer discharges the minimum monomer, and the discharge current is the set current, and the maximum is 10A;
4. Cycle 1 to 3 steps successively until the pressure difference is within the set range.

### 7.2. Single moving capacity

The formula for calculating the capacity of an equalizer is balancing current / 3600 \* Duration (2-5S)  
For example, if the balanced current is 10A, the single transfer capacity ranges from 0.005Ah to 0.0138Ah.

If the capacity of the balanced battery is relatively small or the capacity difference is relatively small, there will be too much capacity transfer, such as the capacity difference between the largest monomer and the smallest monomer is 0.1AH, and at this time the balance current is set to 10A, there will be too much capacity transfer, the smallest monomer becomes the largest monomer after the end of the current balance cycle, and the largest monomer becomes the smallest monomer. The simplest solution to this is to turn down the equilibrium current.

### 7.3. Small-capacity balancing policy

In response to the situation of excessive energy transfer caused by small capacity differences, the 10A equalizer has designed a balancing strategy to cope with this situation. When the balance cycle ends, the original smallest monomer becomes the largest monomer, the largest monomer becomes the smallest monomer, the equalizer waits for 3 minutes, so that the battery voltage has a recovery time, if 3 minutes later or the maximum becomes the minimum, the minimum becomes the maximum, it indicates that the balance is indeed overdone, at this time the equalizer automatically reduces the balance current by half. For example, the original 10A current balance is now reduced to 5A current balance. If there is still an overbalance situation, continue to reduce the balance current until the pressure difference is within the set range.

## 8. Installation method and precautions

### 8.1. Unpacking check and precautions

1. Handle the packing boxes and equalizers gently and do not turn them upside down;
2. Before unpacking, pay attention to whether the package is intact, such as whether there are impact marks, whether there is damage, etc.

## 8.2. Instructions for installing the equalizer

1. A single equalizer can connect up to 24 battery strings in series. As shown in 8.2. 1.
2. When used for battery packs with less than 24 string cells in series, the empty pin is suspended. As shown in 8.2.2.
3. Two power supply methods, the lowest number of string connection method supported. As shown in 8.2.3.1 and 8.2.3.2.
4. When used in cascades, at least one battery between every two equalizers is the common end of the energy exchange. As shown in 8.2.4.

### 8.2.1. 24S Wiring Diagram

The use of battery power or DC adapter power supply, its wiring method is the same, only the following two differences:

- ① Battery power supply support 4S-24S, voltage balancing accuracy  $\pm 3\text{mV}$ ;
- ② DC adapter power supply support 2S-24S, voltage balancing accuracy  $\pm 1\text{mV}$ .

The following figure shows how to install and connect the 24S battery pack:

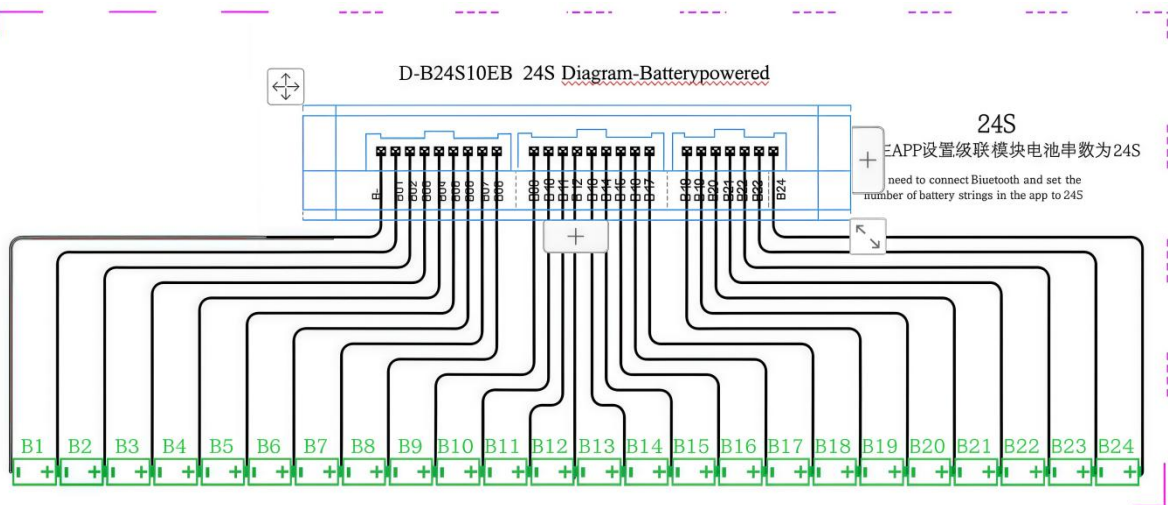

Figure 8.2.1

### 8.2.2. 16S Wiring Diagram

When less than 24 battery strings are connected in series, empty pins are suspended. The following uses 16S as an example.

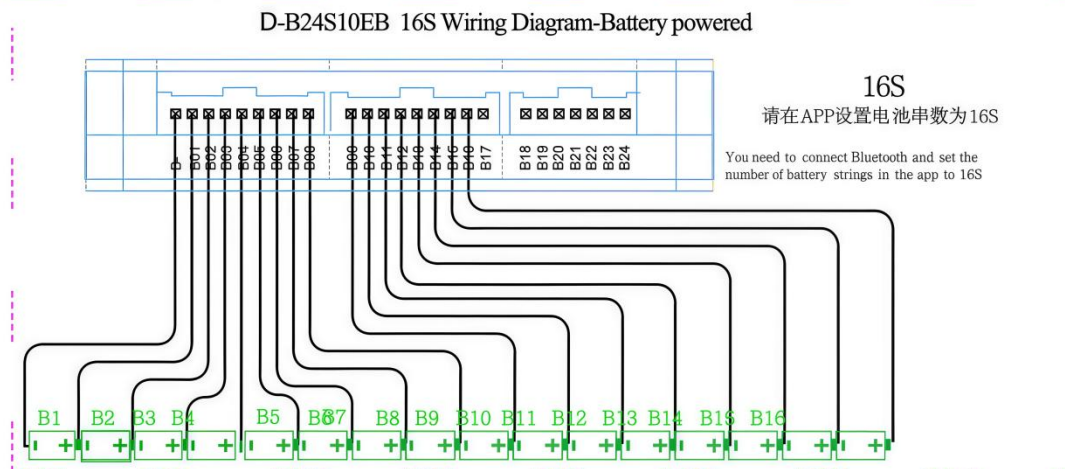

Figure 8.2.2

### 8.2.3. 2S/4S Wiring Diagram

#### 2S Wiring Diagram

When DC power is used, at least two battery strings in series can be connected. The following figure shows the installation and connection method:

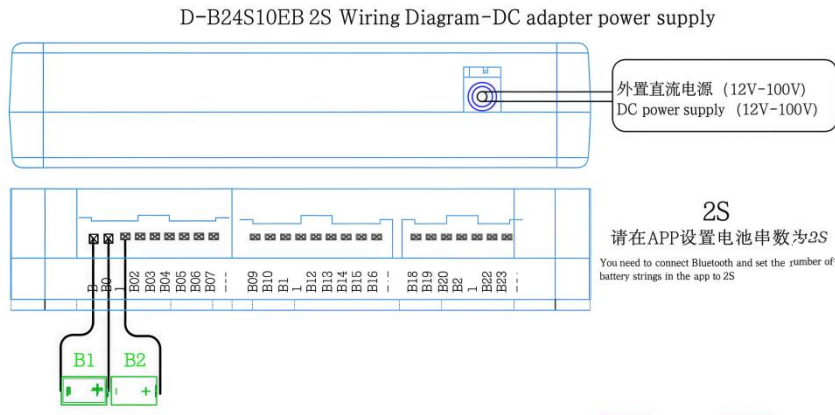

Figure 8.2.3.1

### 8.2.4. 36S Cascade Diagram

The D-24S10EB can be used in cascading mode.

At least one battery is used as the common end of the energy exchange between two equalizers. The following uses 36S as an example.

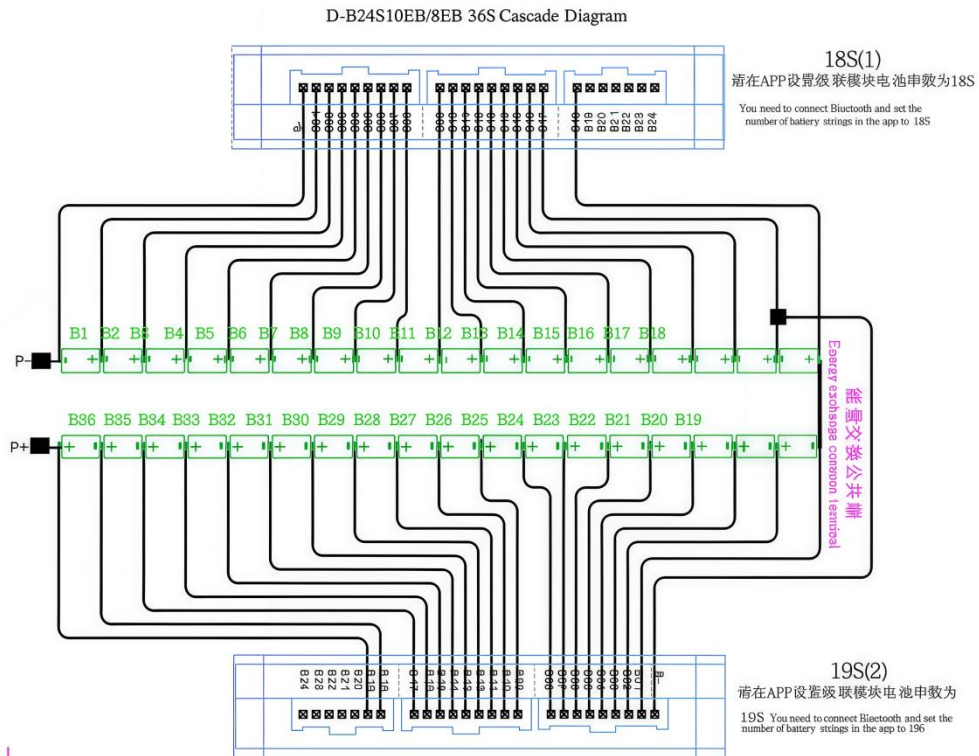

Figure 8.2.4

## Wiring precautions:

1. Installing an equalizer requires a certain amount of knowledge about electronics.
2. When connecting cables, solder the terminal cable to the battery string, and then insert the equalizer.
3. When cascading is used, there is at least one common end of energy exchange between each two equalizers. During welding, pay attention to whether the connection is correct and whether there is a phenomenon such as false welding.
4. The cascade is used in a high-voltage environment. Please check whether the wiring is incorrect. If it cannot be used after connection, please contact after-sales personnel for the corresponding cascade diagram.

## 9.APP Installation and Use

### 9.1.APP Installation

The APP has two versions of Android system and IOS system, both support Chinese and ten other languages iOS and Android users can search and download it from the app store.: **PowerDogbms**

Or go to the official website download center to download the installation package.

Official website: <http://www.powerdogbms.com> //



### 9.2.APP Use

#### 9.2.1.Pre-use inspection

1. After downloading the APP, you must enable the location and location information and allow the APP to use the location information. If the location is not enabled, the equalizer cannot be searched and the device cannot be connected.
2. Before powering on the power supply, check whether the equalizer is properly connected, whether the power supply for the equalizer is within the required range, whether the equalizer is properly placed, and whether there is short circuit on the circuit board.

#### 9.2.2.APP Connect device procedure

The first step is to connect the device, as shown below; After the unconnected device enters the APP, the system will automatically start scanning the device.

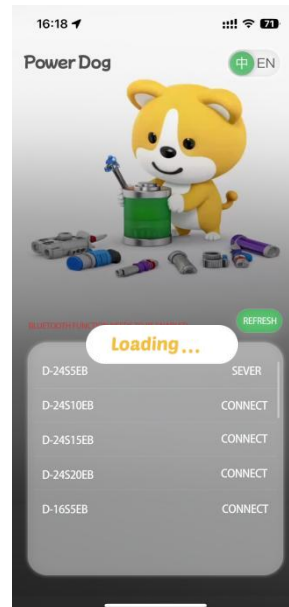
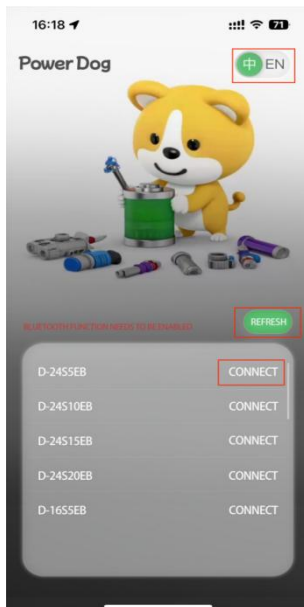

# Power Dog

The second step, after the connection is successful, start the balance switch,  
You can also modify the parameters first (enter the password for the first time)

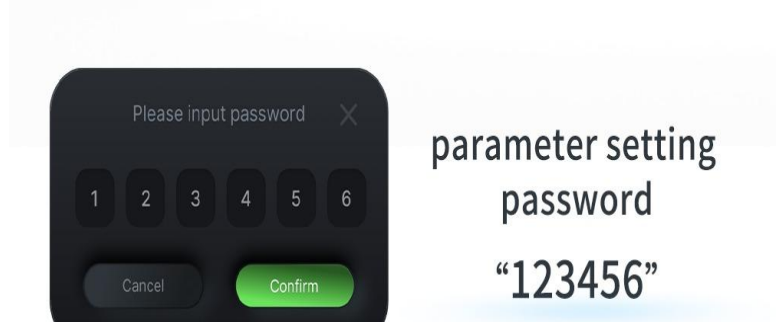
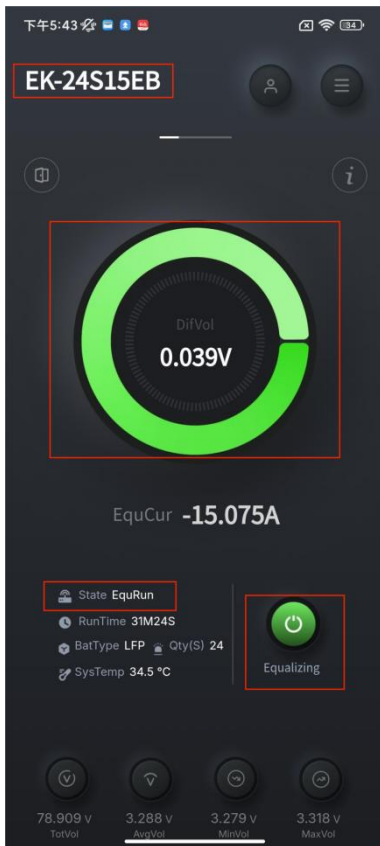

The third step, according to the battery type and battery string number, change the parameters ,  
as shown in the figure below;

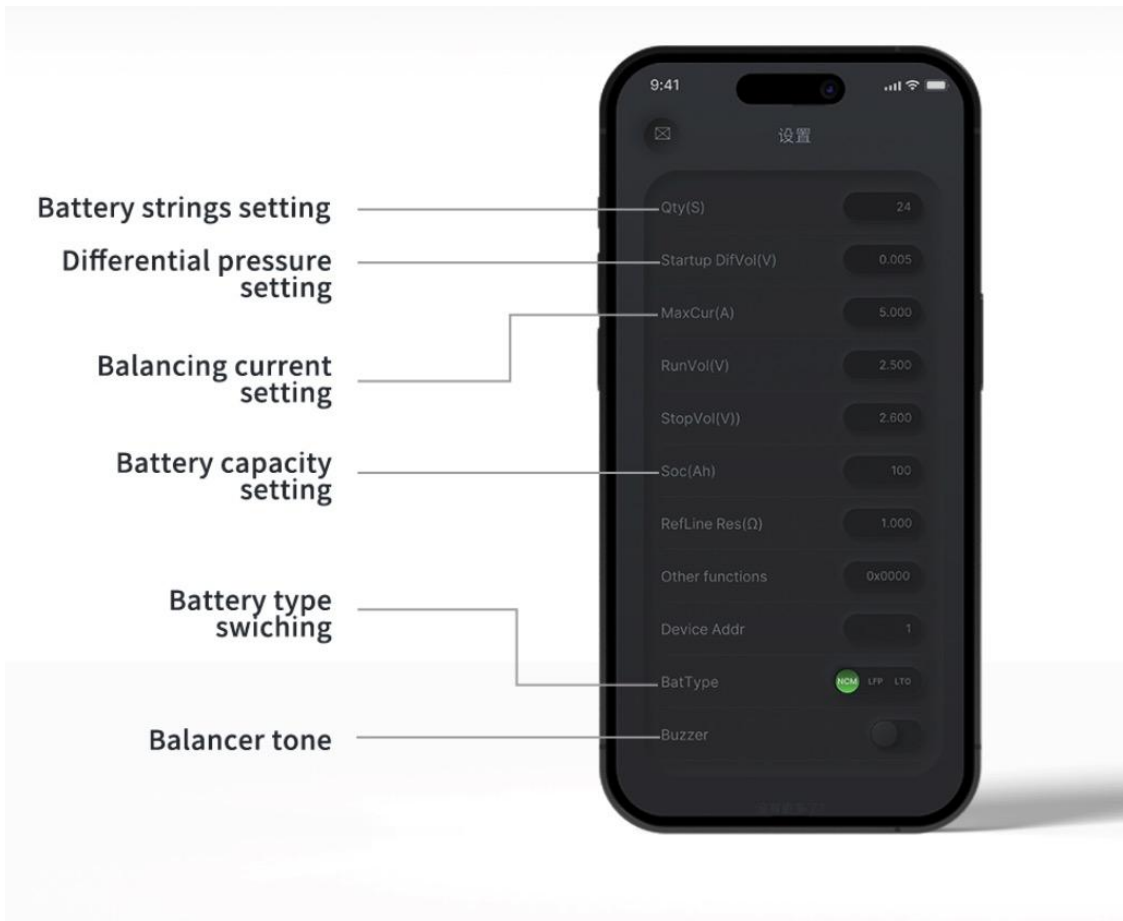

# Power Dog

Fourth, after setting the required parameters, you can monitor the parameters of each monomer from the "Status" or "Alarm" page;

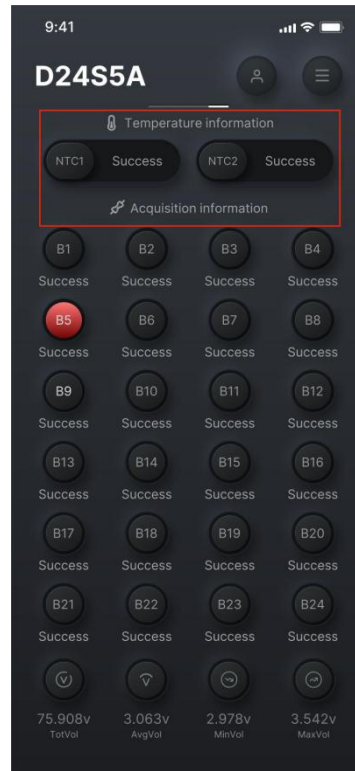

Step 5: Disconnect the device or replace the connected device.

(If you want to maintain equilibrium, do not close the equilibrium)

Special note: Turn off the "balance switch" or remove the power/battery pack, and the equalizer will stop running.

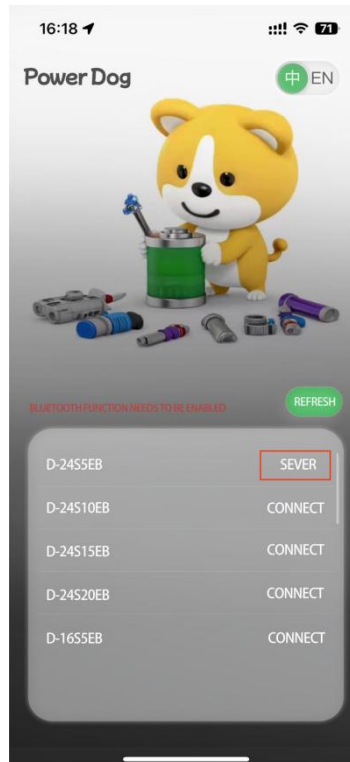
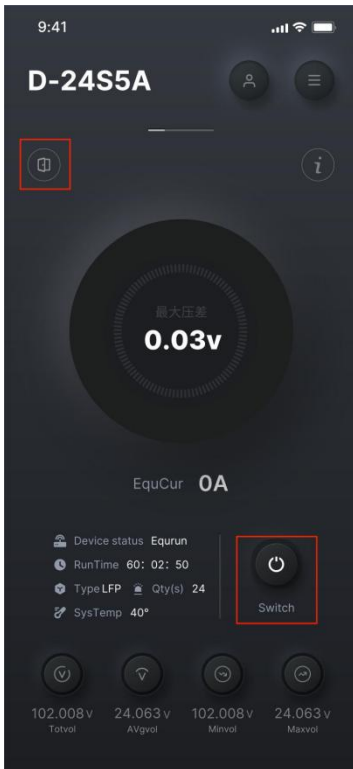

Finally, the steps for viewing device information, switching white themes, and changing device passwords are shown in the following figure.

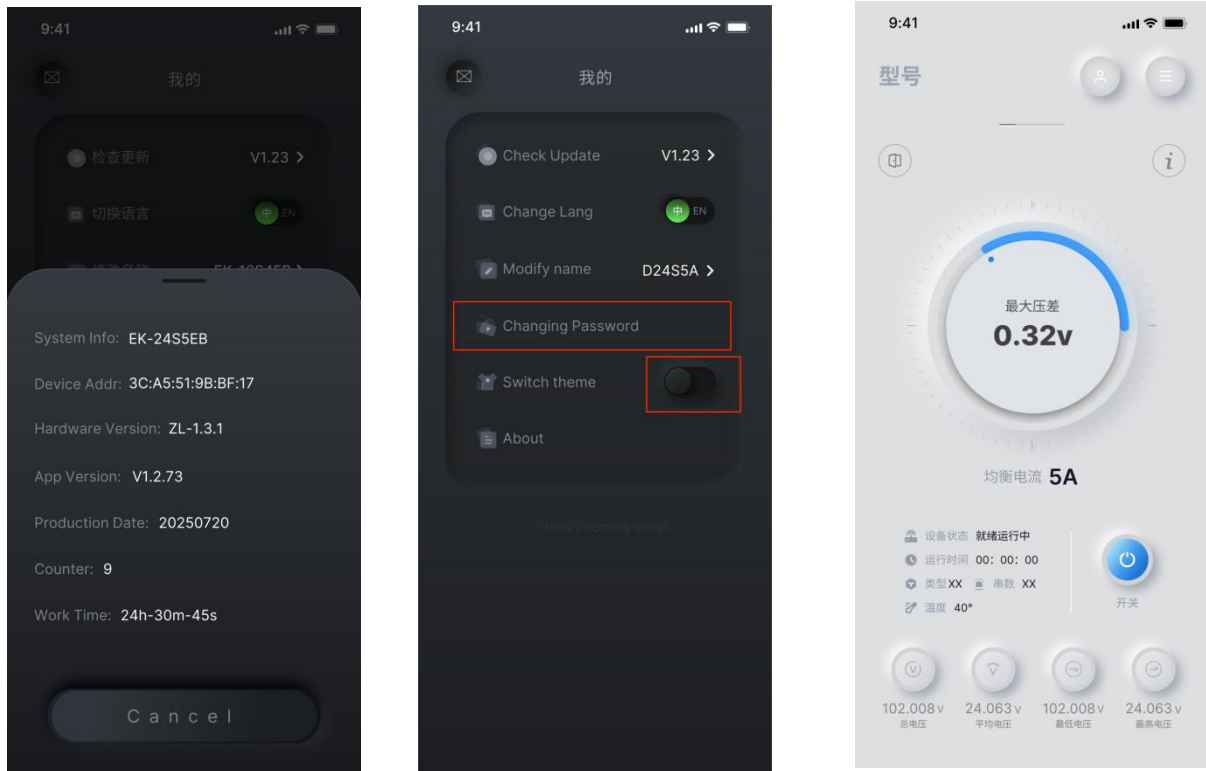

### 9.3.Notice

- ①. The equalizer defaults to 24S for the first time, so when you use it for the first time, the connected battery pack is not 24S, and the fault indicator will light up, which is a normal phenomenon. Because the number of strings set in the APP is inconsistent with the number of battery strings actually connected, in this case, modify the battery parameters after the connection is successful and then enable the balance.
2. When a fault occurs, the balance cannot be enabled.

## 10. Phenomenon description

### 10.1. General fault analysis and elimination

No.	Fault Phenomenon	Analysis Of Causes	Final Solution
1	The power indicator is off	The power supply to the equalizer is abnormal	<p>① Check whether the electric source pin of the equalizer is connected correctly;</p> <p>② If the battery string is less than 25V, an external 30V to 100V DC power supply is required</p>
2	Device not found	The APP has no relevant authorization	<p>① Check whether the Bluetooth is turned on;</p> <p>② Turn on location and location information and allow the APP to use location information.</p>
3	The equalizer does not start	The equalizer does not meet working conditions	Check whether the first battery voltage is higher than 2.4V, if not meet the conditions, please charge the battery to more than 2.4V, and then the equalizer will automatically start.
4	The APP prompts that the number of monomer Settings does not match the set value	The number of units set or the balance line is improperly connected	<p>Check whether the number of units configured is the same as the number of connected batteries.</p> <p>If it is different, change the number of battery strings actually connected in the APP.</p>
5	The APP indicates that the resistance of the balance line is too large	The cable resistance from the battery to the connector is too large	Check whether the cable between the battery unit and the connector is in poor contact. If no, replace the cable.
6	Inaccurate voltage acquisition	Cables are incorrectly connected or parameters are incorrectly set	<p>Check the connection one by one to eliminate connection errors.</p> <p>Fine-tune through the voltage acquisition reference until the acquisition is accurate.</p>
7	Cannot be cascaded	There is no energy exchange common end	Contact customer service or after-sales personnel to consult the wiring diagram for your desired cascade.

Special note: The above are the possible causes of common faults and solutions, if the fault is still not removed, please contact Jingwei power after-sales.

## 10.2. Buzzer alarm description

No.	Fault Phenomenon	Analysis Of Causes	Final Solution
1	The buzzer goes off twice every one second (Red fault indicator lights up when ringing).	The hardware data store is faulty	contact the manufacturer
2	The buzzer sounds three times every 0.5 seconds (Red fault indicator light up when ringing).	Bluetooth communication error	contact the manufacturer
3	The buzzer sounds four times every 0.5 seconds (Red fault indicator light is only on at intervals)	The device hardware is faulty. The supercapacitor voltage overvoltage	contact the manufacturer

Special note: Hardware problems rarely occur, mostly caused by hardware damage caused by operation errors.  
You can try to reconnect the device several times.

## 10.3. Buzzer description

No.	Phenomenon	Notes
1	After the device is powered on, the buzzer rings four times. (The green light is on at this time)	
2	After the balance is enabled, the buzzer sounds. (The yellow light is blinking at this time)	
3	After the equalization is complete, delay 3 minutes and beep. (The yellow light is on at this time)	Need in the Settings, Turn on the buzzer function.

## **11.Safety protection measures and transportation and storage**

### **11.1.Safety precautions**

1. The equalizer itself does not have high pressure and will not cause electric shock damage to the body.
- ②. There are no user repairable parts inside the equalizer. All repairs should be performed by qualified maintenance personnel. If the operating voltage set by the factory is changed, the safety certificate is no longer applicable.
- ③. Before touching the sampling line of the equalizer, discharge the static electricity and take ESD preventive measures.

### **11.2.Transportation**

The packaged products can be transported by the usual means of transport without being directly affected by rain and snow and violent collisions.

It is not allowed to be put together with corrosive substances such as acid and alkali during transportation.

### **11.3.Storage**

Packaged products should be placed in a permanent warehouse storage, warehouse temperature is 0°C~35°C, relative humidity is not more than 80%,

There should be no acid, alkali and corrosive gases in the warehouse, no strong mechanism vibration and impact, and no strong magnetic field.



Shenzhen Jiatong Electronics Co., Ltd

 Web: [//www.powerdogbms.com](http://www.powerdogbms.com) //

 TEL: +8613612992617

 Address: Room 519, Block A, Jiada R&D Building, No. 5 Songpingshan Road, Songpingshan Community, Xili Street, Nanshan District, Shenzhen